

Kompozit Panel Cephe Kaplama Sistemi

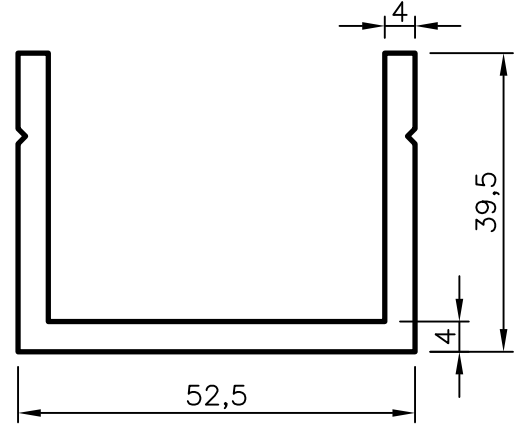

No : 3545
Kompozit Panel U Profili
1,350 kg/m

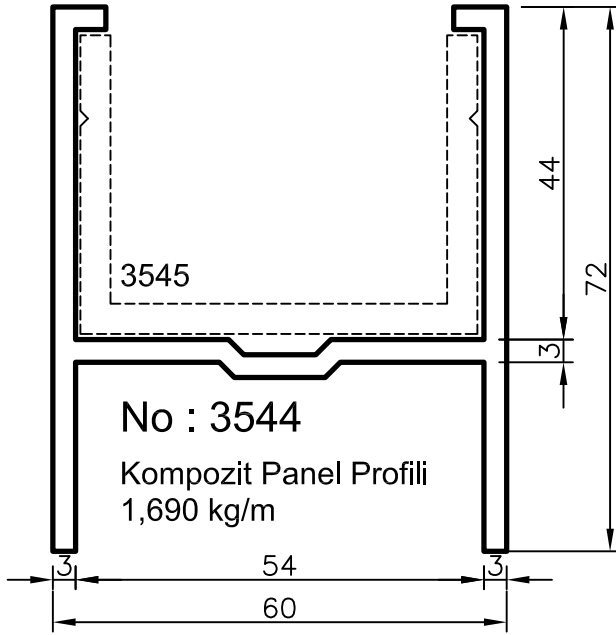
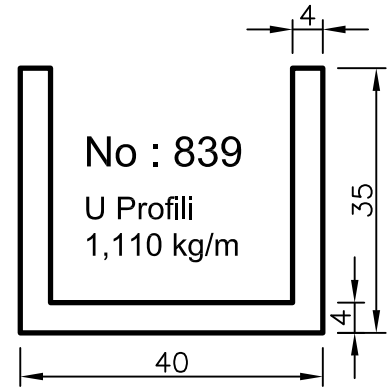
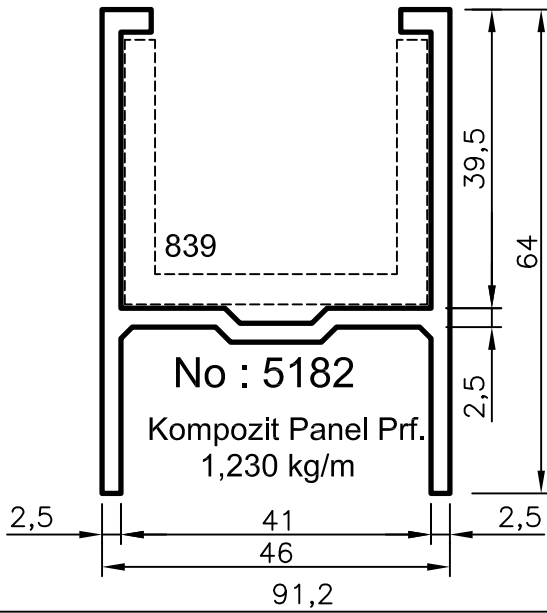

No : 504

Ø 8 Dolu Çubuk
0,140 kg/m

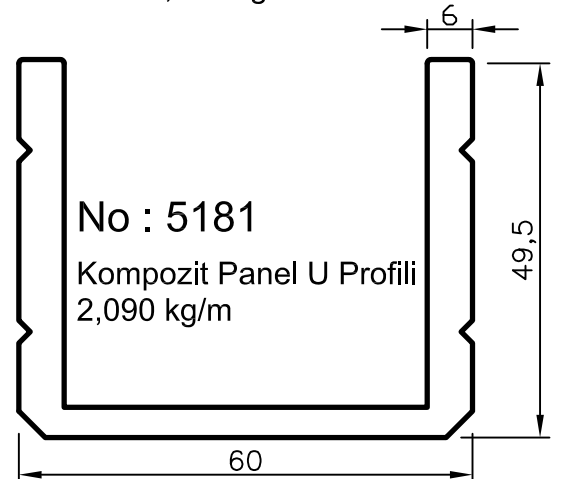
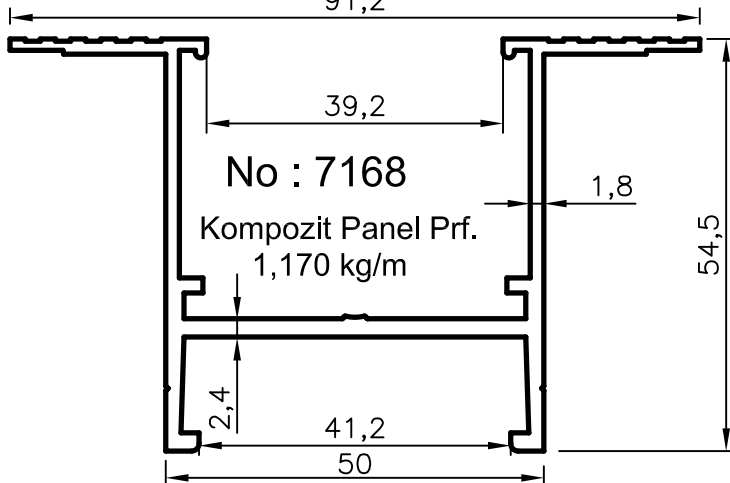

Kompozit Panel Cephe Kaplama Sistemi

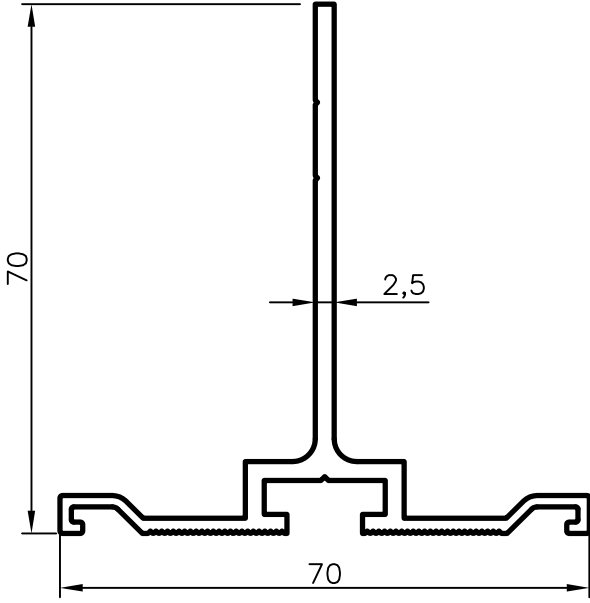

No : 8598

Taşıyıcı Profil
0.910 kg/m

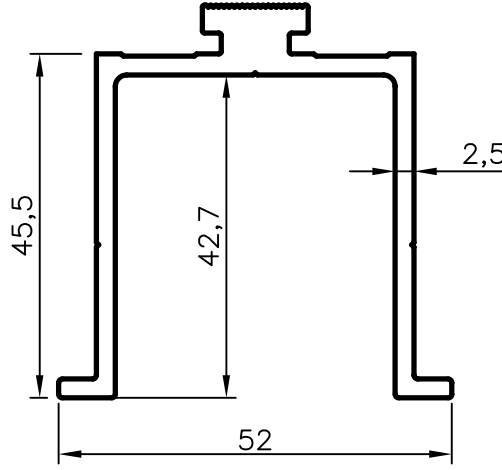

No : 8599

Taşıyıcı Profil
1.160 kg/m
SC-510 (50 tk/pk)

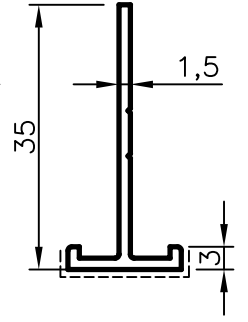

No : 8707

Derz Profil
0.215 kg/m

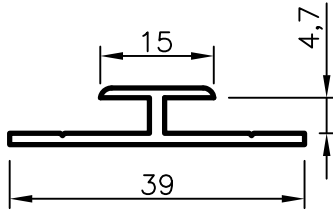

No : 3452

Kompozit Panel
Ek Yeri Profili
0.245 kg/m

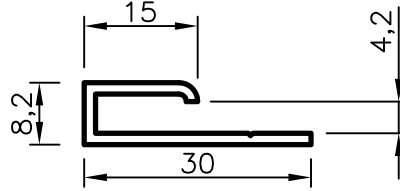

No : 3454

Kompozit Panel
Bitiş Profili
0.205 kg/m

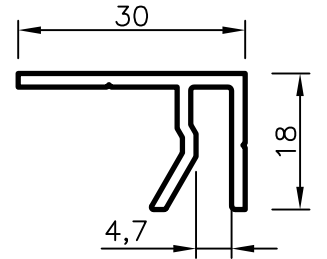

No : 3958

F Profil
Bitiş Profili
0.320 kg/m

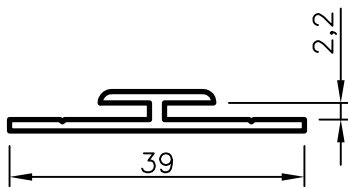

No : 3453

Levha Ek Yeri Profili
0.230 kg/m

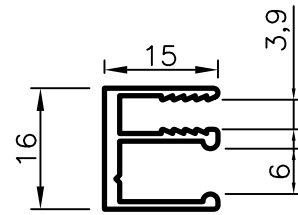

No : 4986

U Profil
0.220 kg/m

Kompozit Panel Cephe Kaplama Sistemi

L BRAKETLER

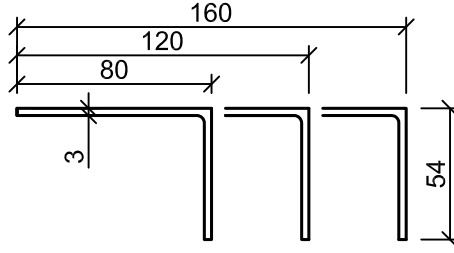

No : 4747

54X80 L

1,075 kg/m

No : 4748

54X120 L

1,400 kg/m

No : 4749

54X160 L

1,725 kg/m

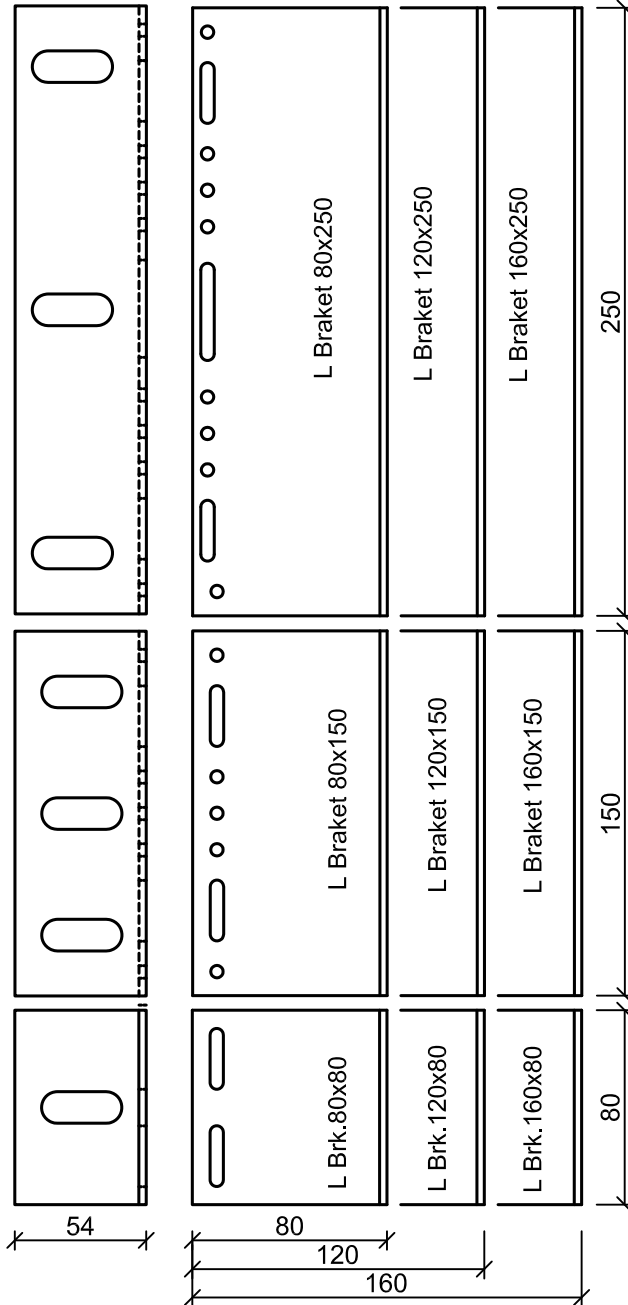

YAN GÖRÜNÜŞ





ÖN GÖRÜNÜŞ

ÖLÇEKSİZ

Uyarı: Profil ağırlıklarımız teorik olup; teslim anındaki tartımız geçerlidir.

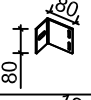
Kompozit Panel Cephe Kaplama Sistemi

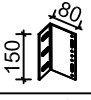
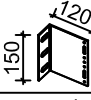
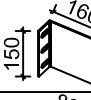
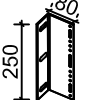
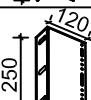
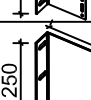
AKSESUAR LİSTESİ

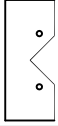
RESİM PICTURE	PARÇA NO PIECE NO	MALZEME MATERIAL	AÇIKLAMA DESCRIPTION	PAKET PACKET
	SC-510		Anahtar geçme askı elemanı " 8598 nolu profille kullanılır."	50 TK/PK
		Alüminyum	54X80X80 L Braket	İstenilen Miktarda
			54X120X80 L Braket	
			54X160X80 L Braket	
			54X80X150 L Braket	
			54X120X150 L Braket	
			54X160X150 L Braket	
			54X80X250 L Braket	
			54X120X250 L Braket	
			54X160X250 L Braket	
	PP110			
			Anahtar geçme kalıbı	1 AD
			V köşe kalıbı	1 AD

Kompozit Panel Cephe Kaplama Sistemi

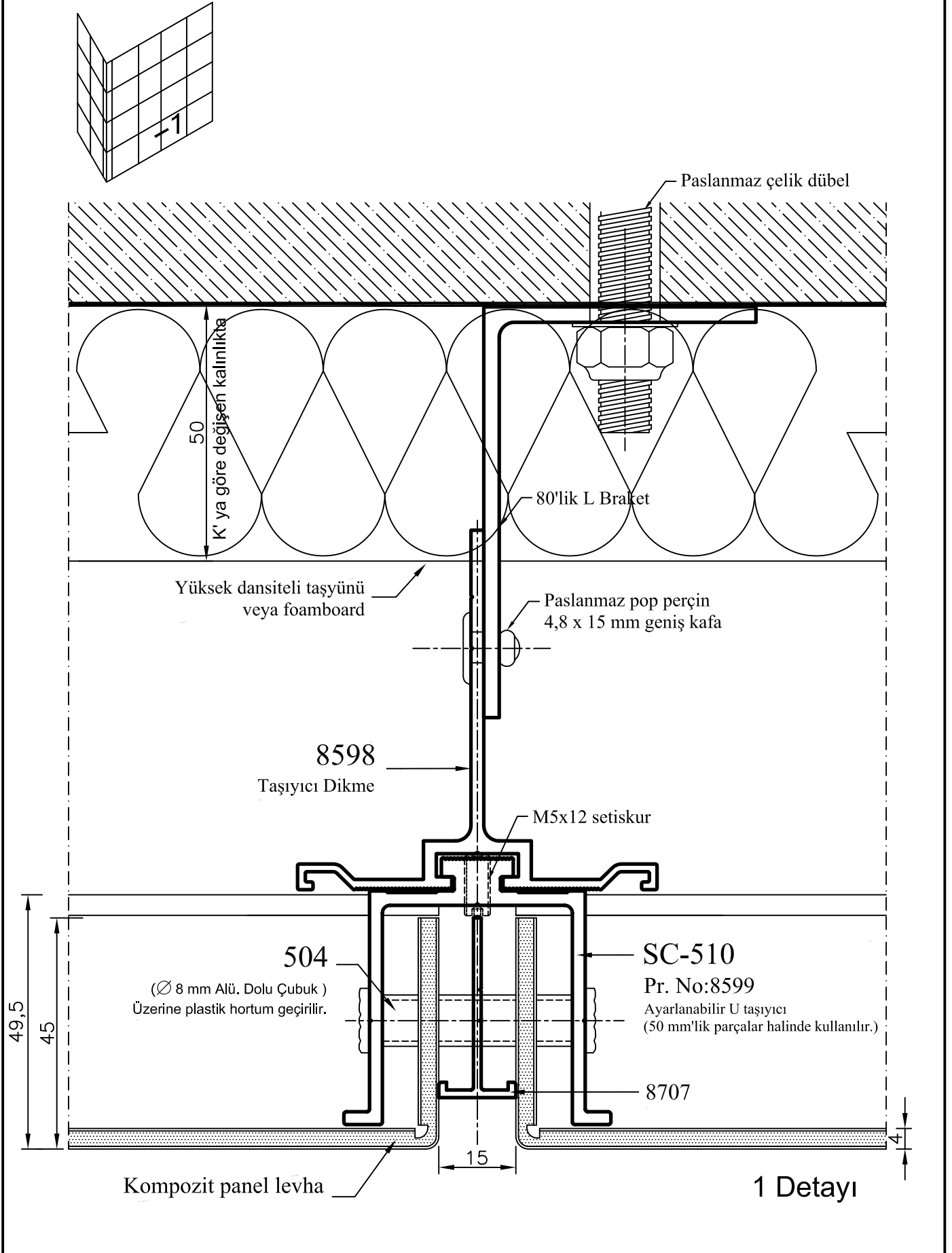

Kompozit Panel Cephe Kaplama Sistemi

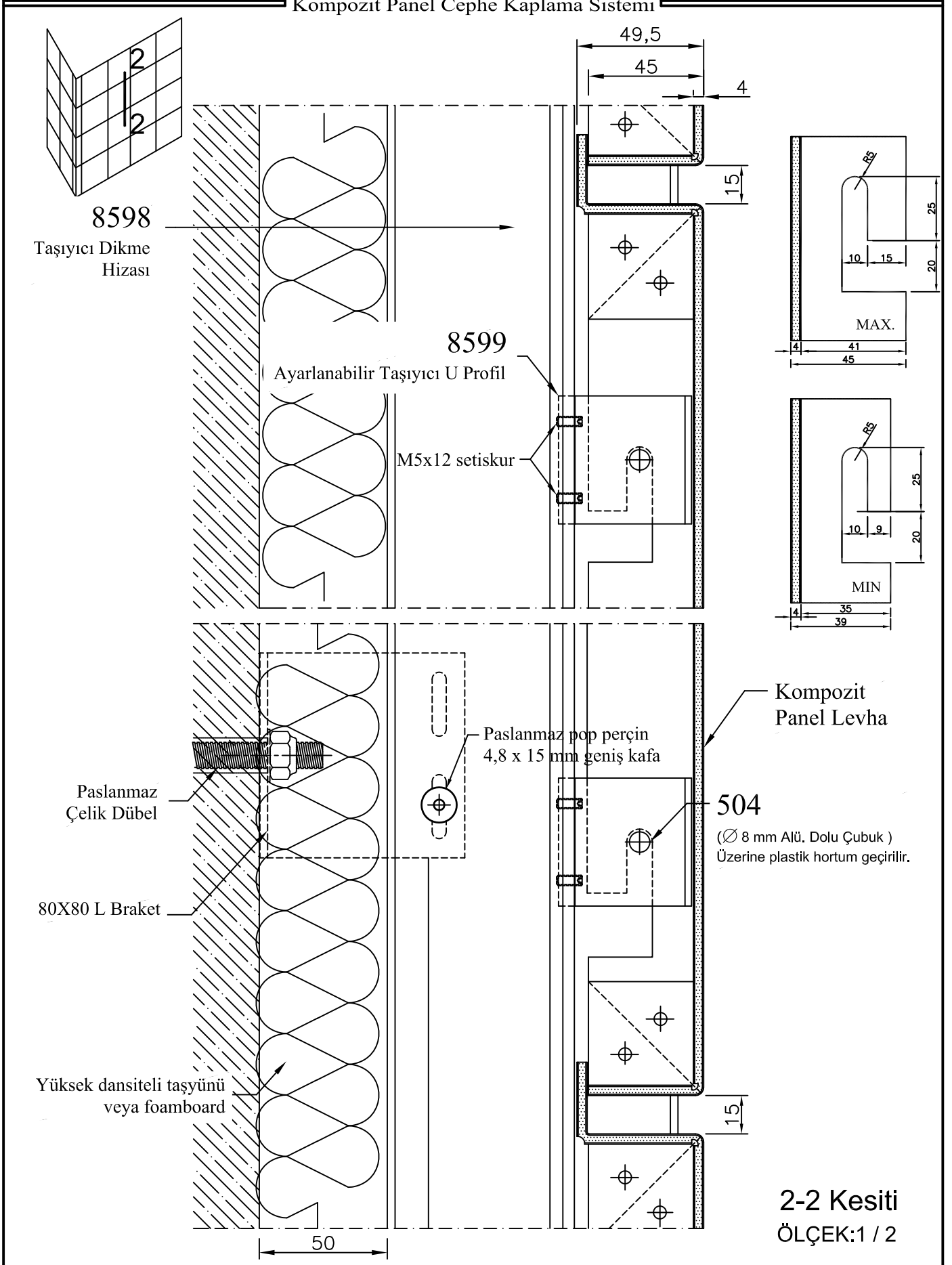

Kompozit Panel Cephe Kaplama Sistemi

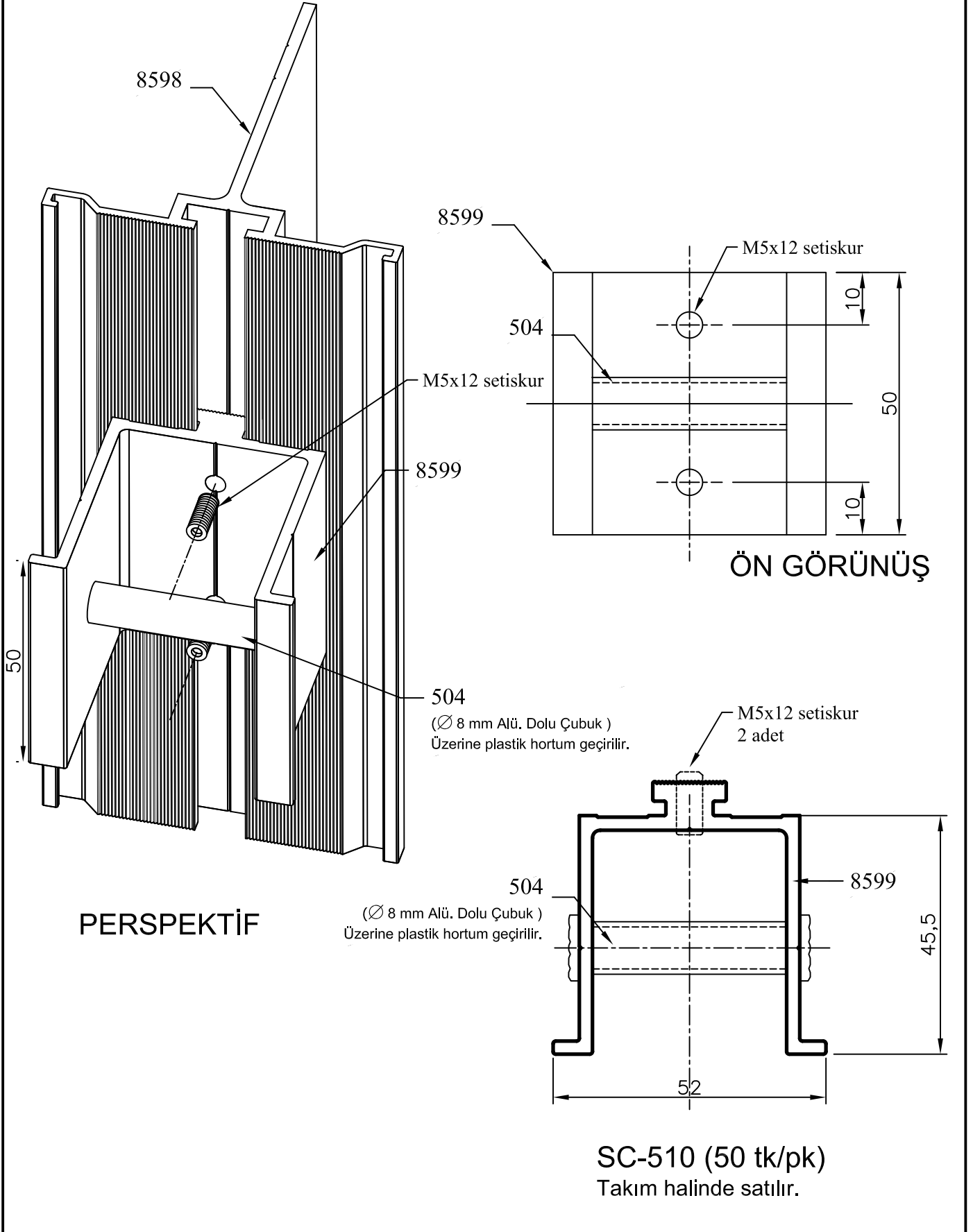

Kompozit Panel Cephe Kaplama Sistemi

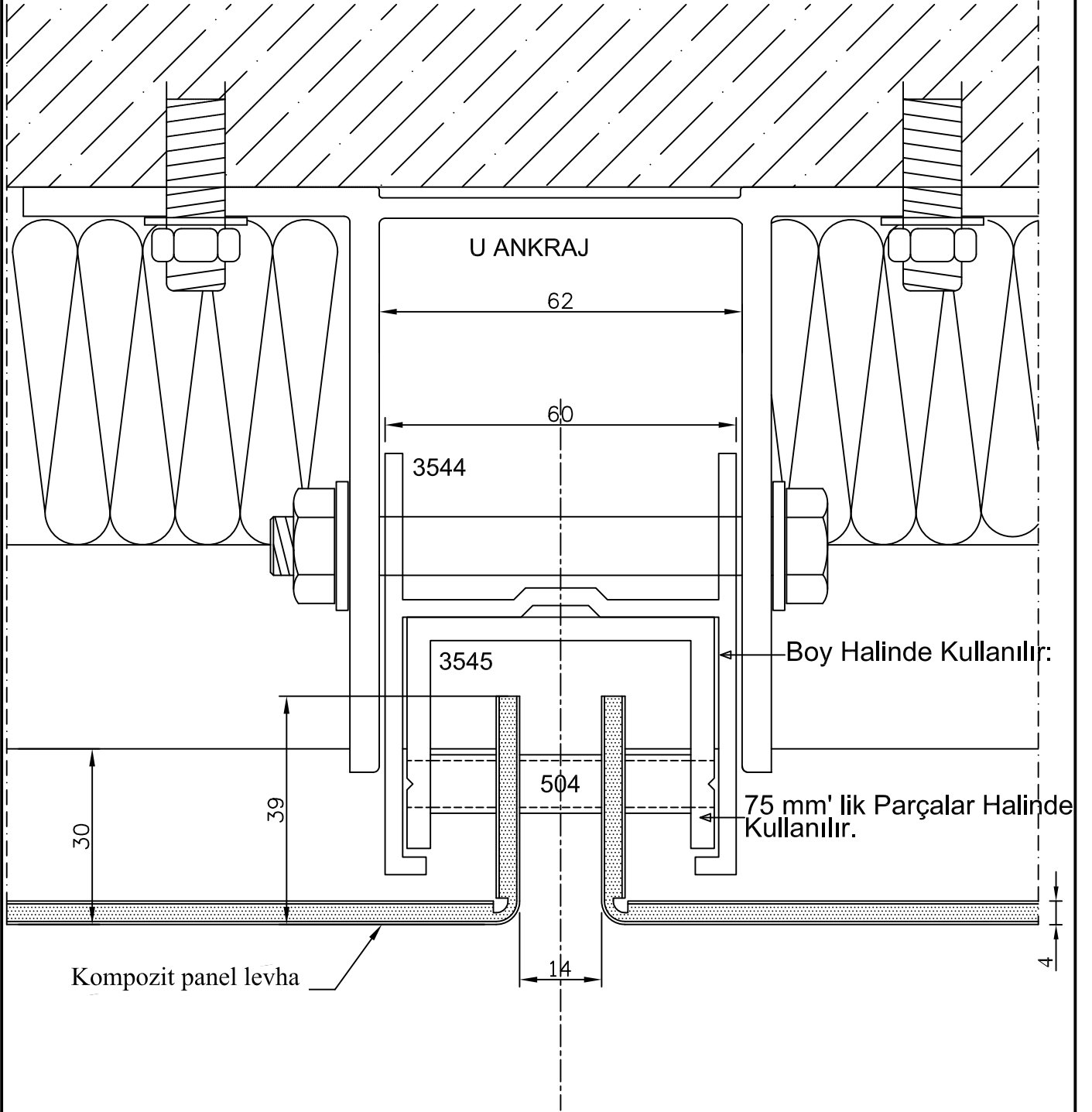
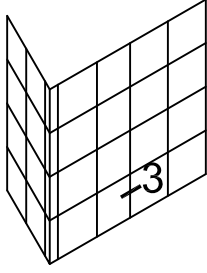

3 Detayı

Kompozit Panel Cephe Kaplama Sistemi

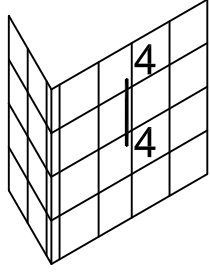

3544
Taşıyıcı Dikme
Hizası

Paslanmaz
Çelik Dübel

U Ankrāj

Yüksek dansiteli taşıyıcı
veya foamboard

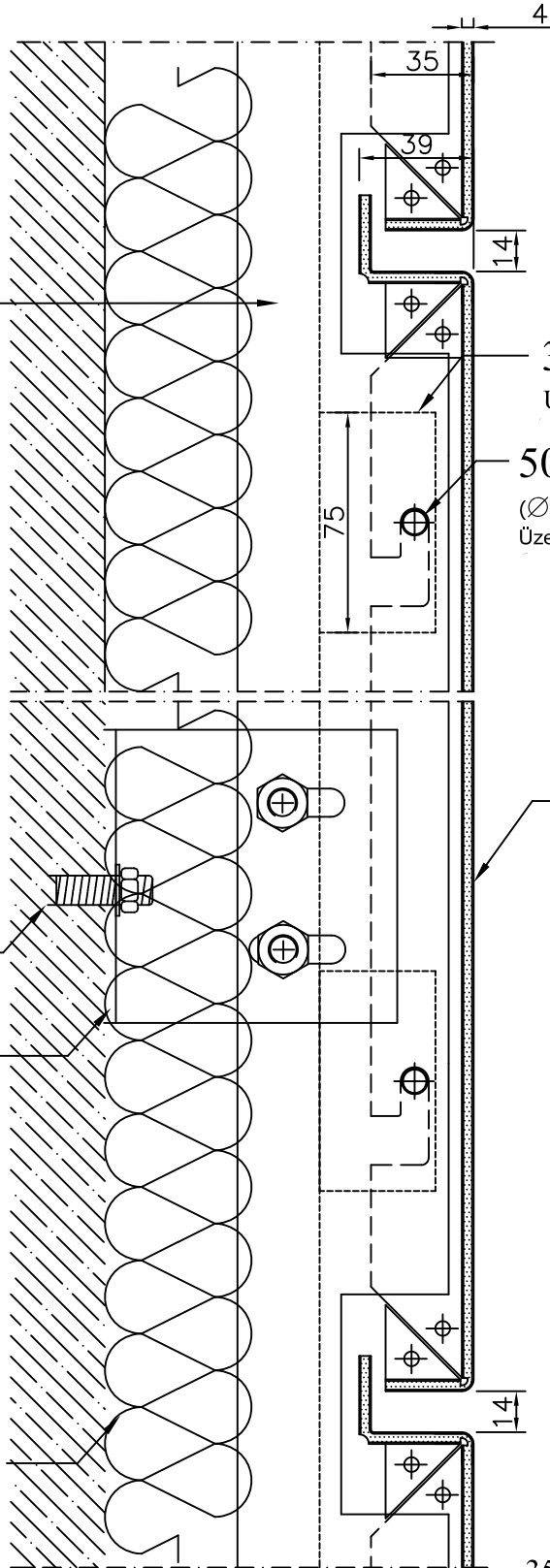

3545
U Profil

504

(Ø 8 mm Alü. Dolu Çubuk)
Üzerine plastik hortum geçirilir.

Kompozit
Panel Levha

4-4 Kesiti

Ölçek:1 / 2.5

3544

3545

504

(Ø 8 mm Alü. Dolu Çubuk)
Üzerine plastik hortum geçirilir.

Kompozit Panel Cephe Kaplama Sistemi

ÖN GÖRÜNÜŞ

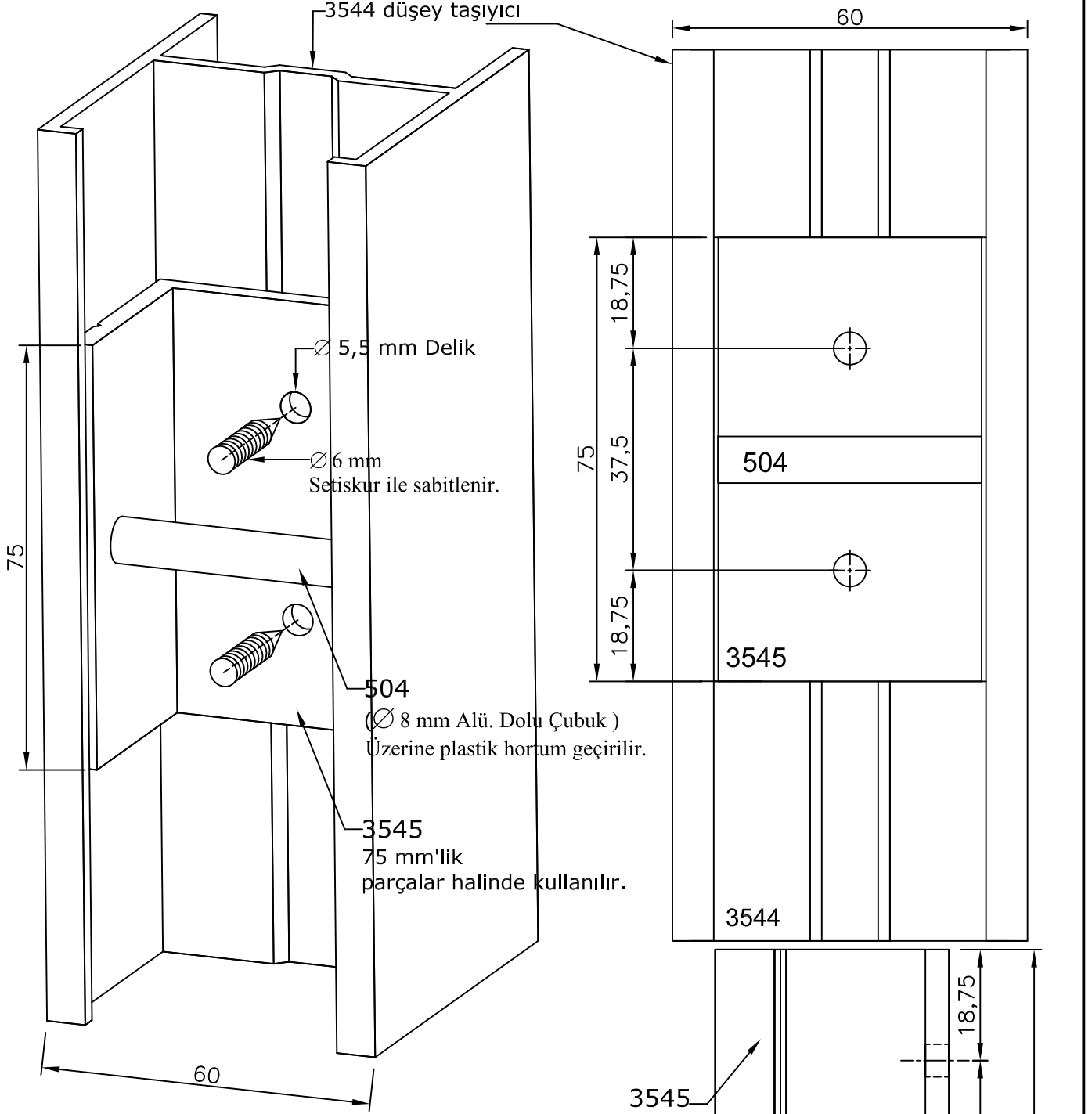

PERSPEKTİF GÖRÜNÜŞ

(\varnothing 8 mm Alü. Dolu Çubuk)
+ Plastik hortum

YAN GÖRÜNÜŞ

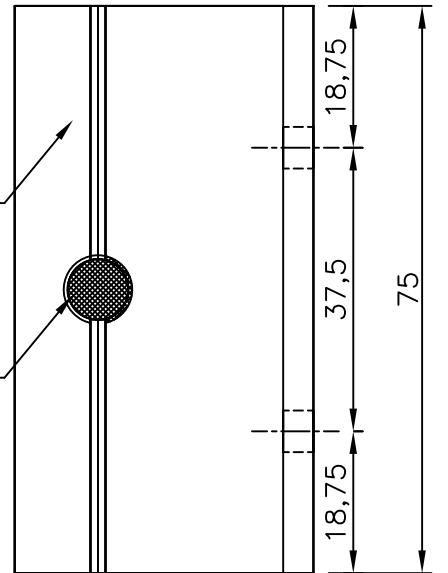

Kompozit Panel Cephe Kaplama Sistemi

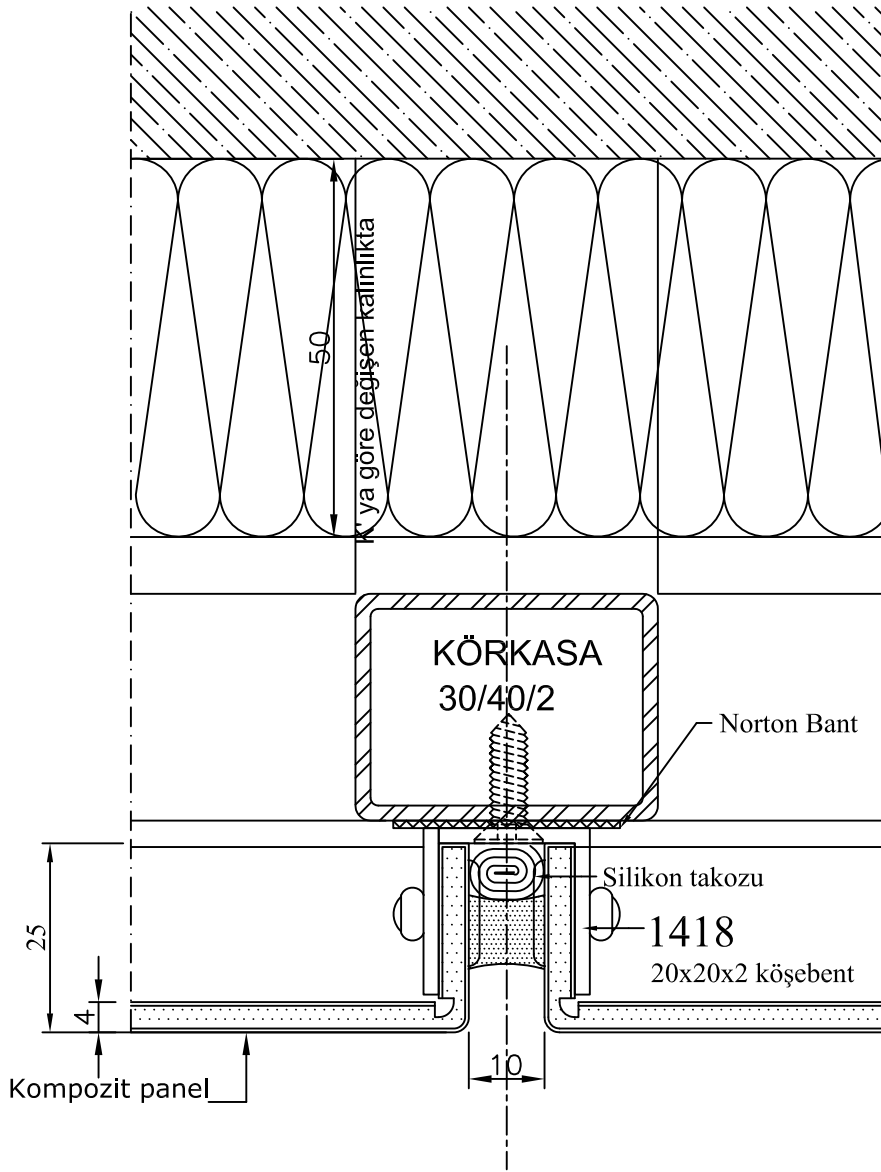
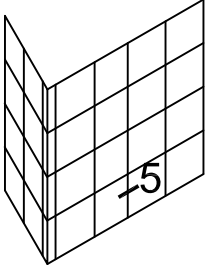

5 DETAYI

Kompozit Panel Cephe Kaplama Sistemi

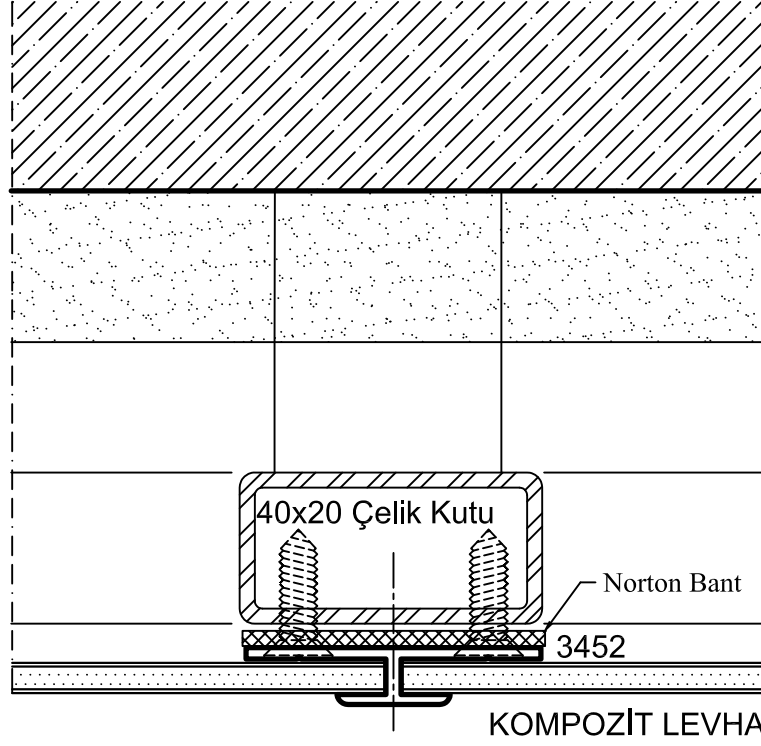
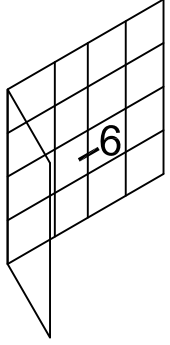

6 DETAYI

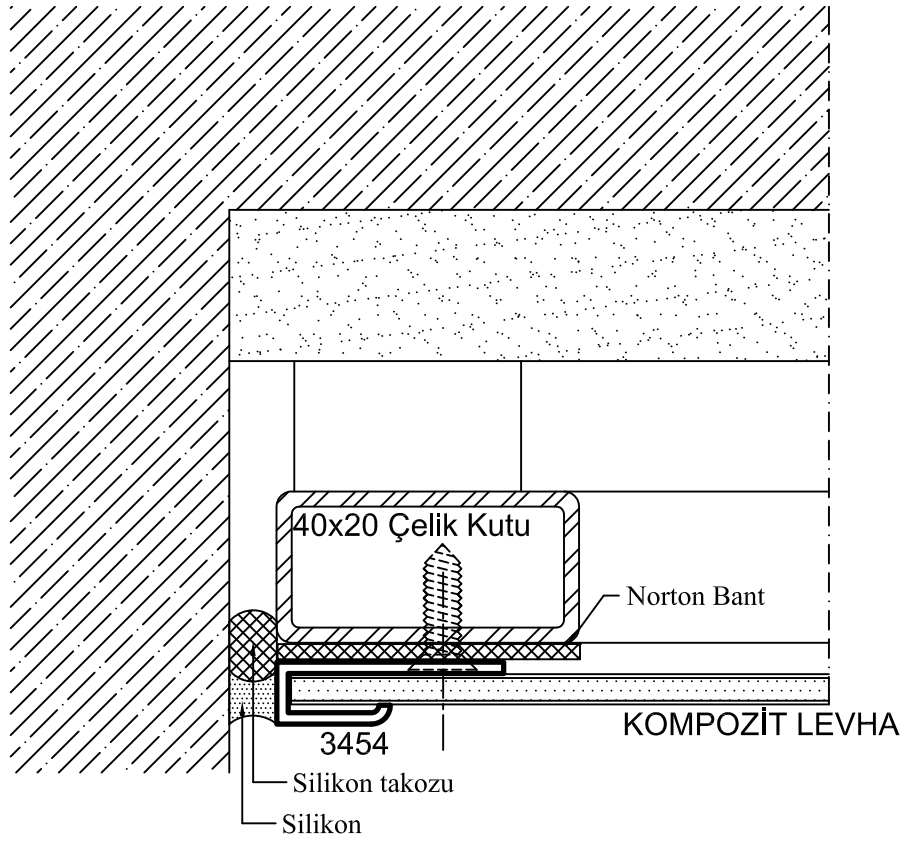
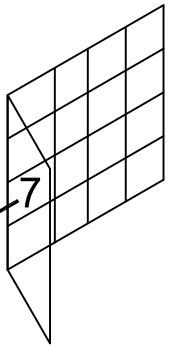

7 DETAYI